

PGC IQ

P12

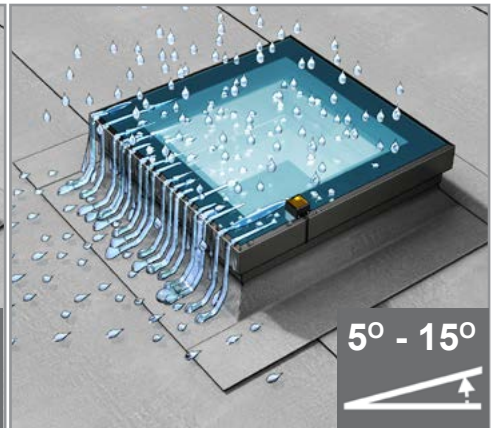

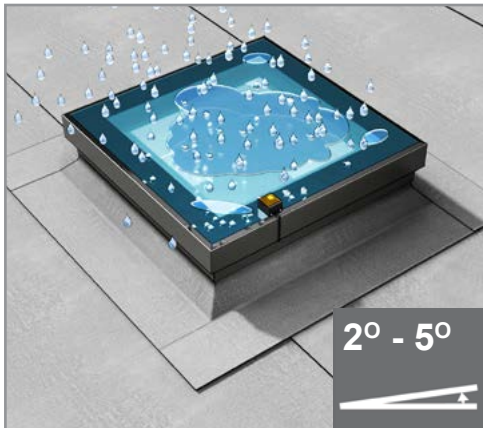
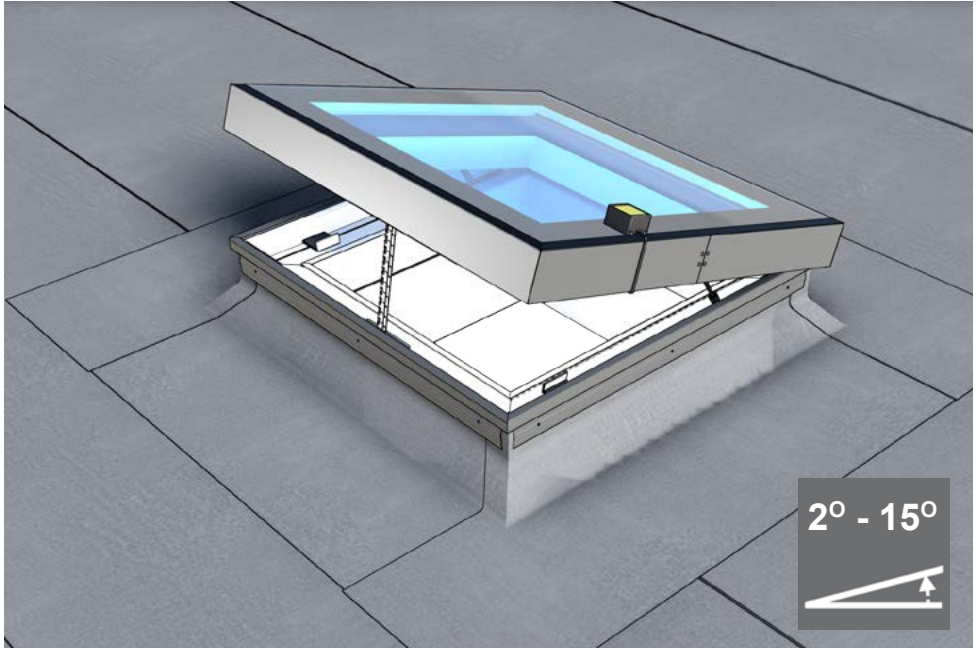
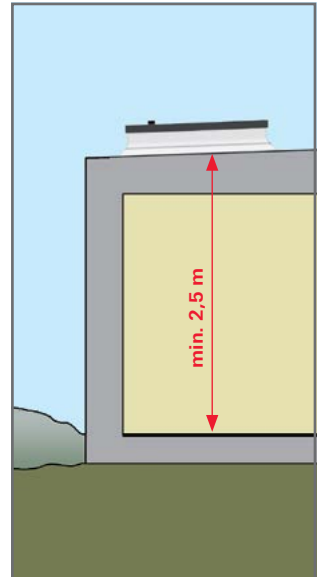
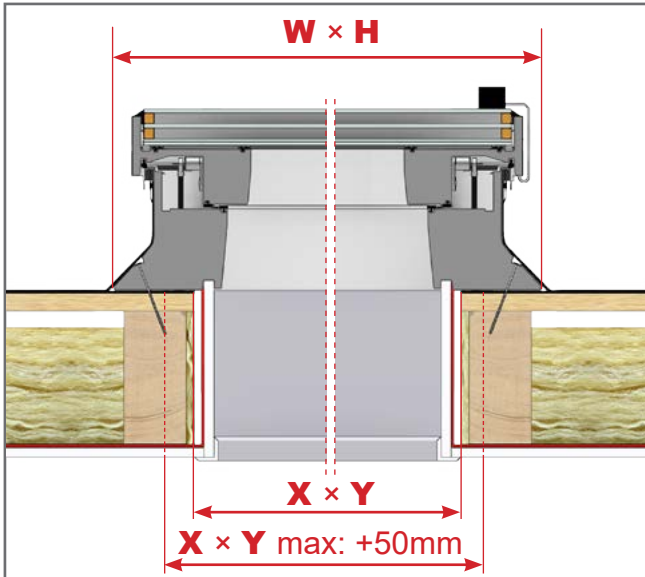
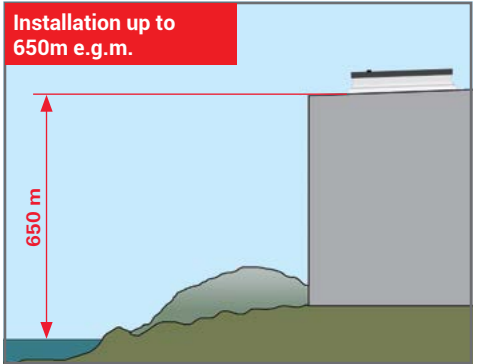
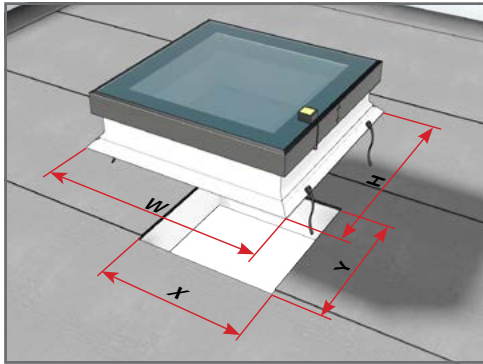

| PGC IQ | X (mm) | Y (mm) | W (mm) | H (mm) |
|-----------|--------|--------|--------|--------|
| 60 x 60 | 600 | 600 | 799 | 799 |
| 70 x 70 | 700 | 700 | 899 | 899 |
| 80 x 80 | 800 | 800 | 999 | 999 |
| 90 x 60 | 900 | 600 | 1099 | 799 |
| 90 x 90 | 900 | 900 | 1099 | 1099 |
| 100 x 100 | 1000 | 1000 | 1199 | 1199 |
| 120 x 60 | 1200 | 600 | 1399 | 799 |
| 120 x 90 | 1200 | 900 | 1399 | 1099 |
| 120 x 120 | 1200 | 1200 | 1399 | 1399 |
| 150 x 100 | 1500 | 1000 | 1699 | 1199 |

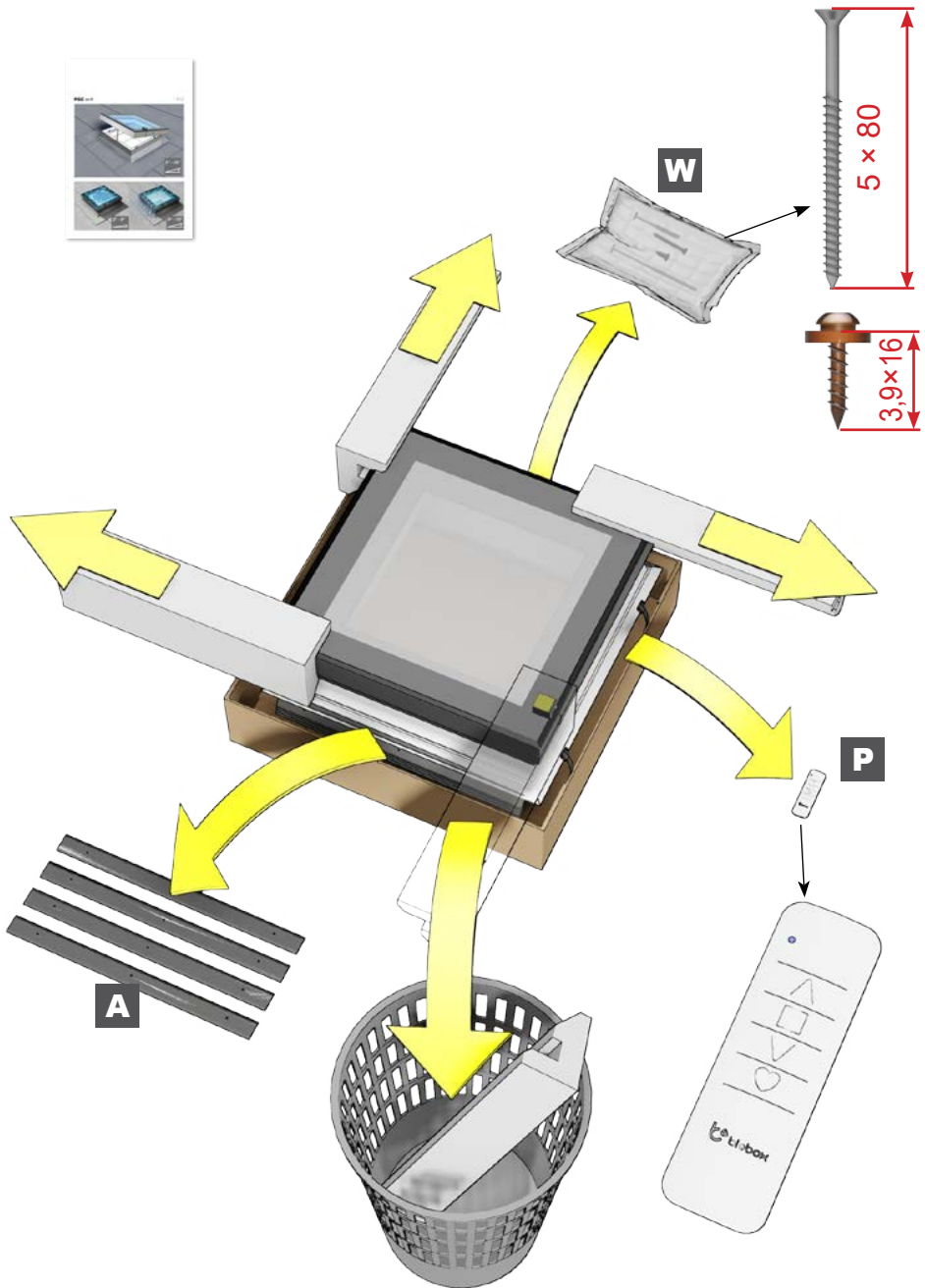

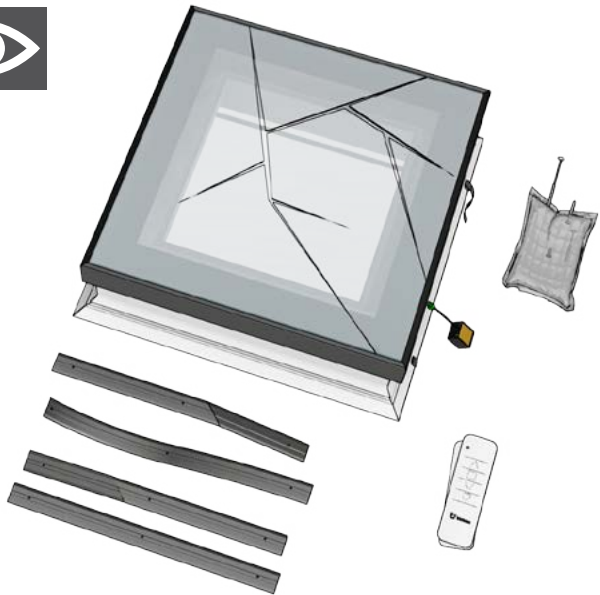

SERVICE



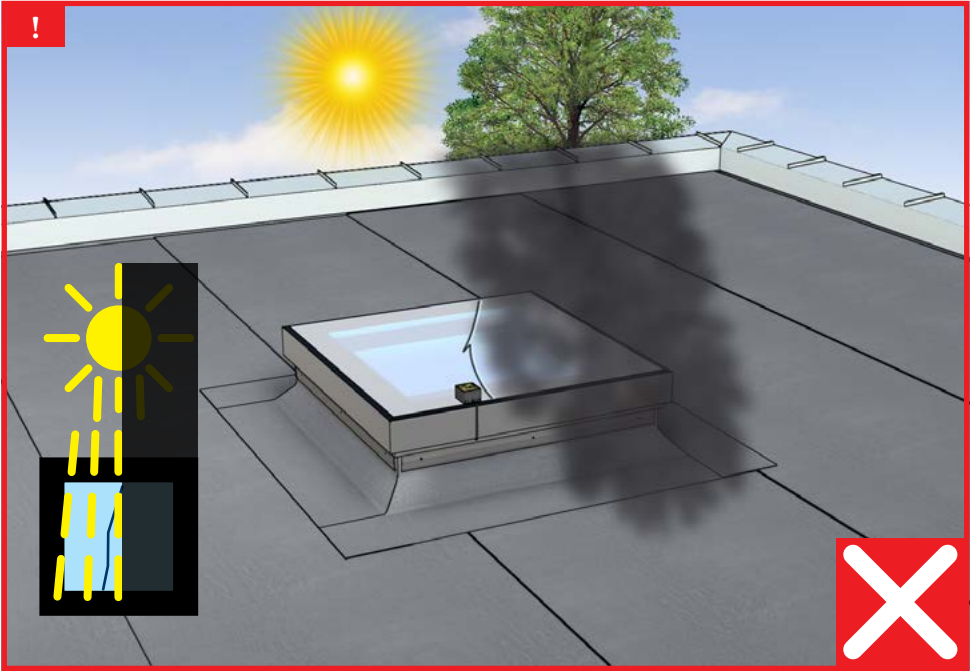
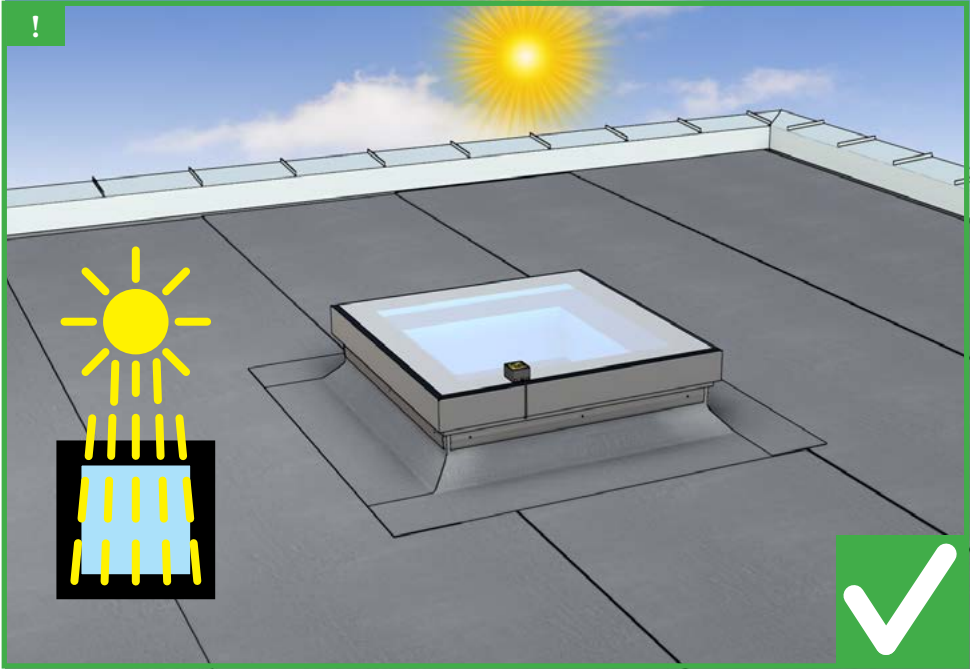

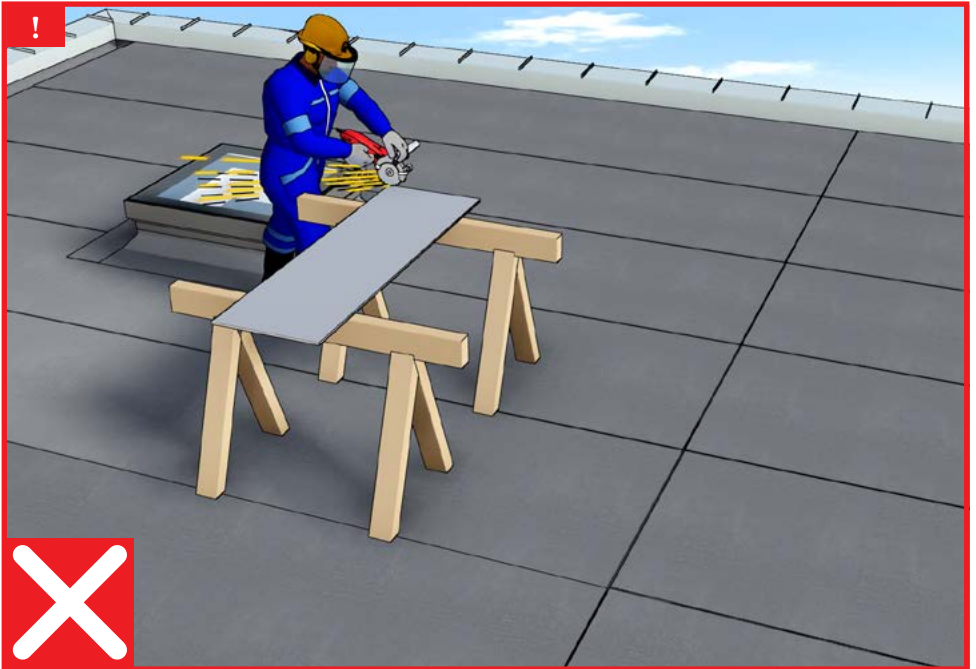

1a

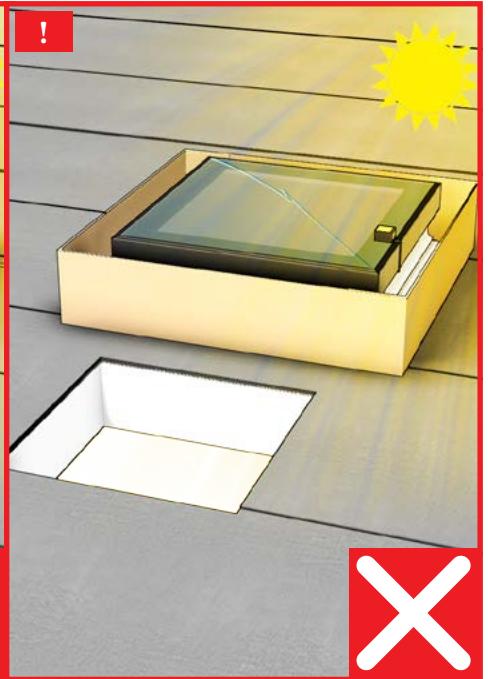
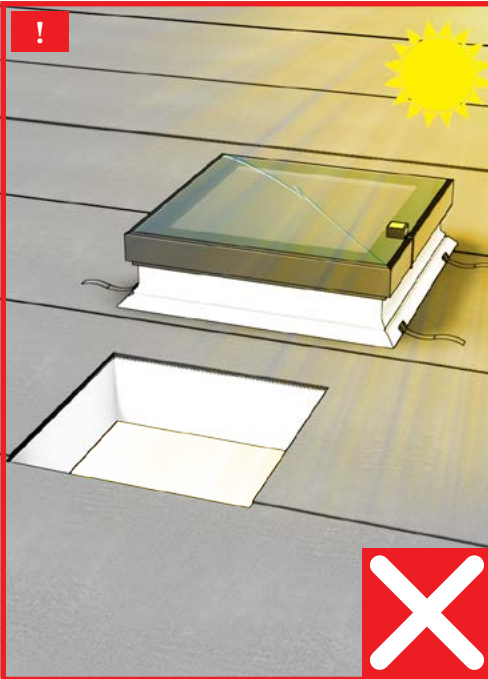

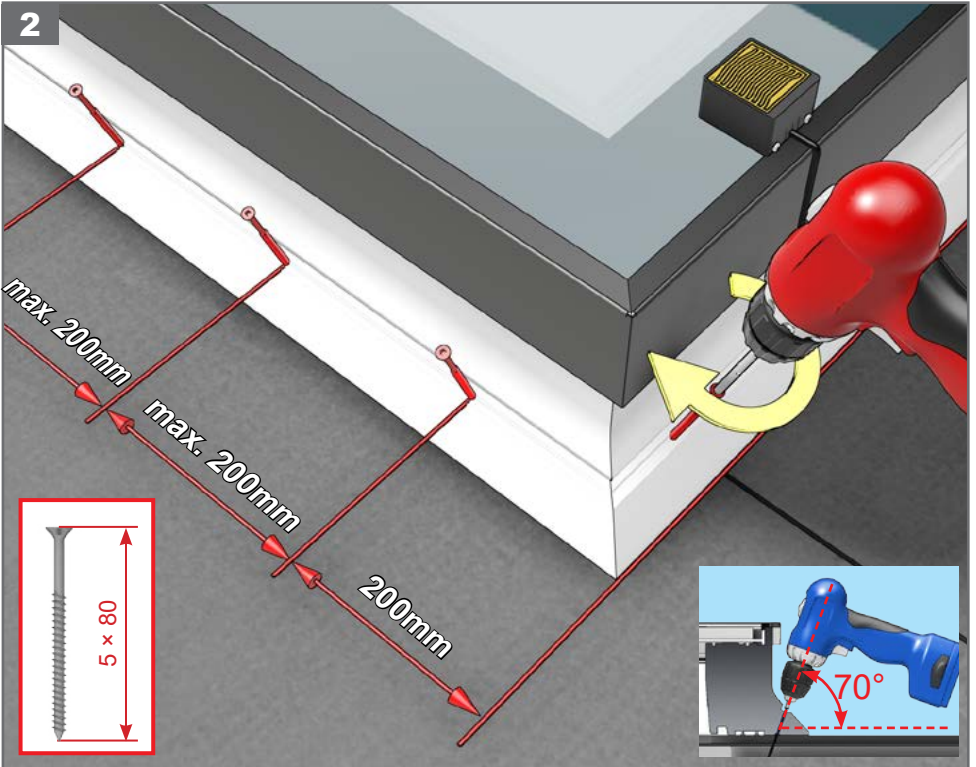
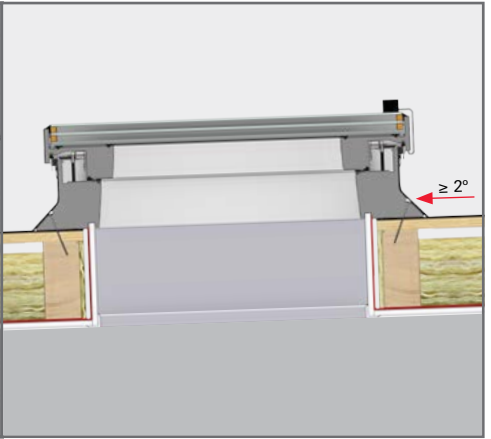
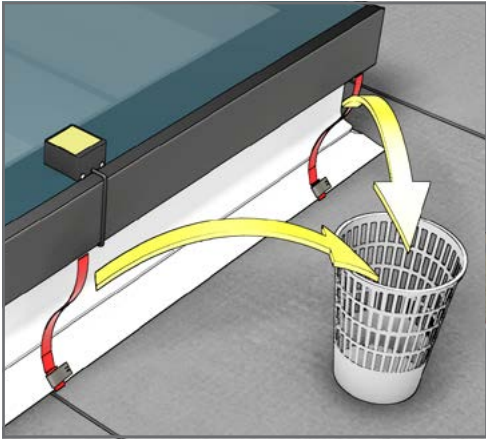
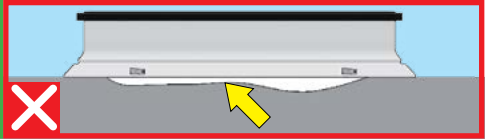
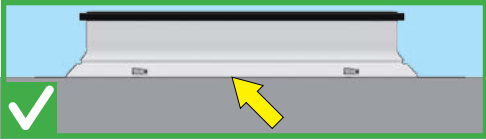

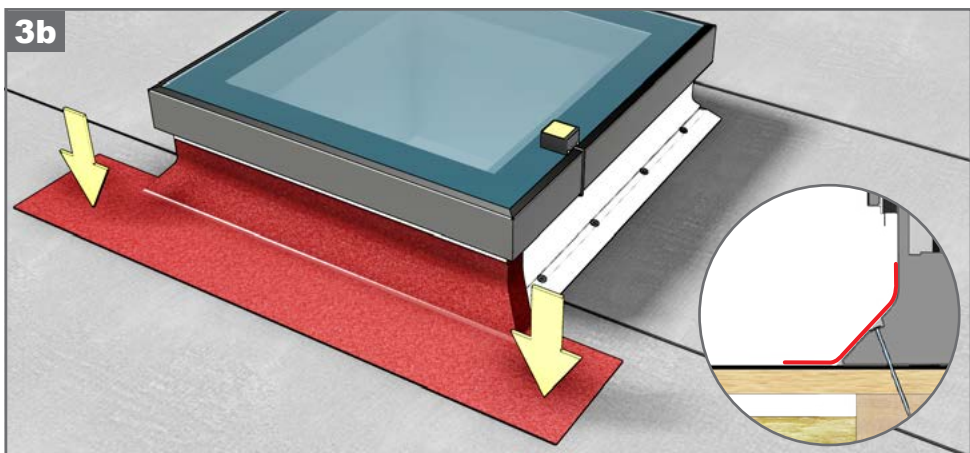

3c

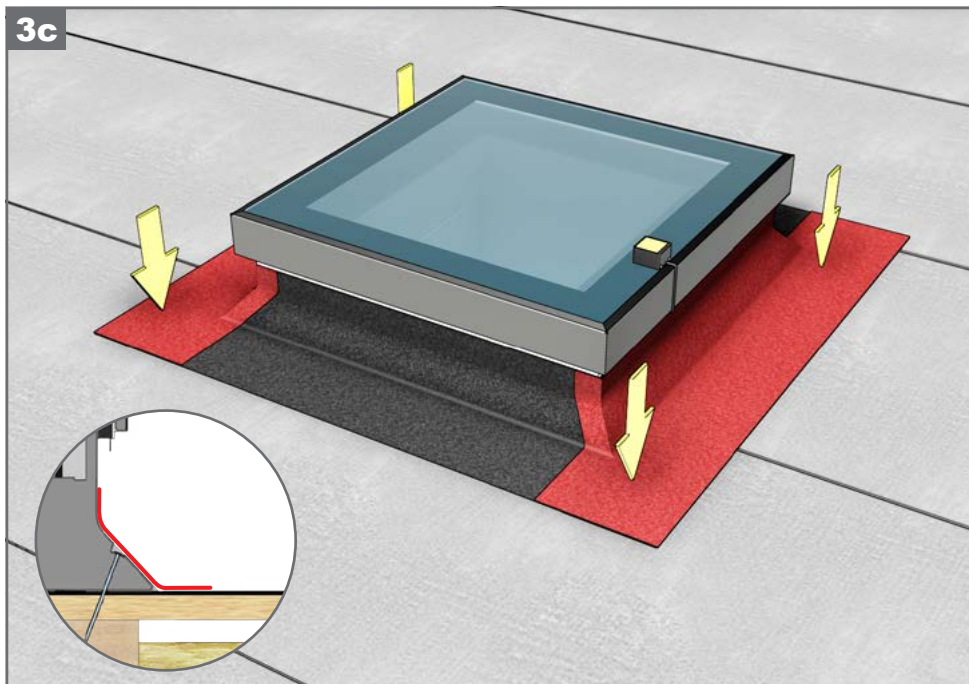

3d

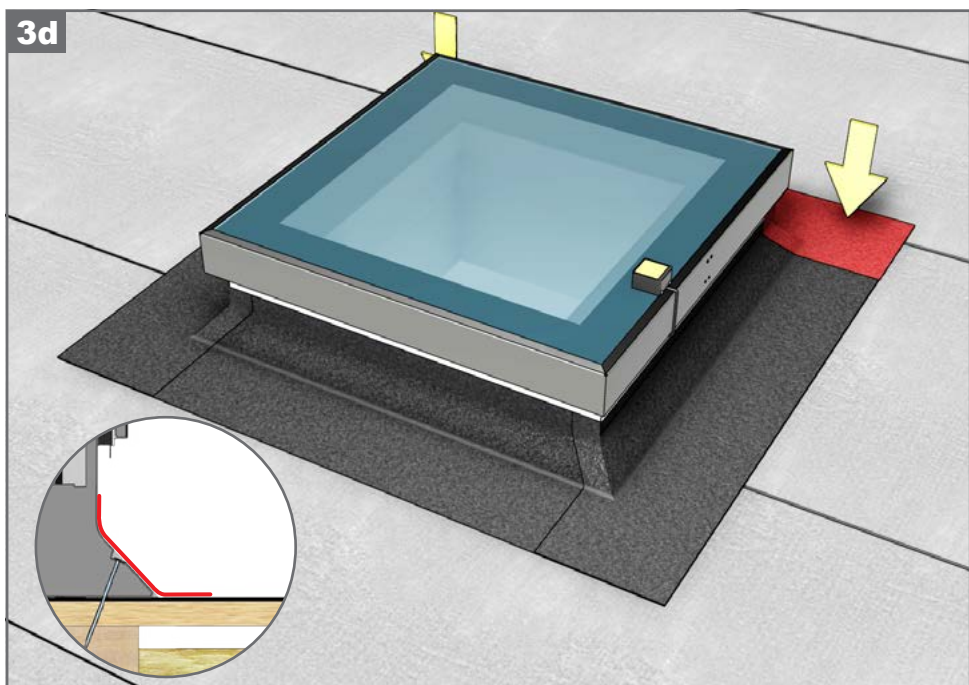

4a

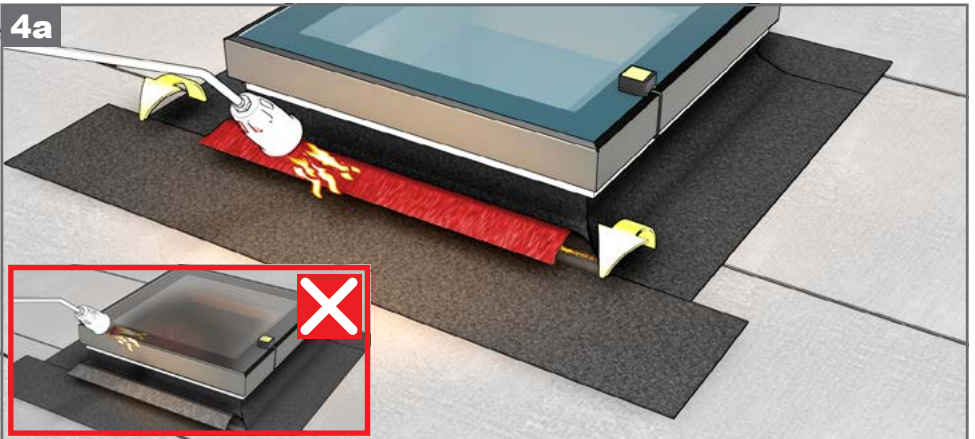

4b

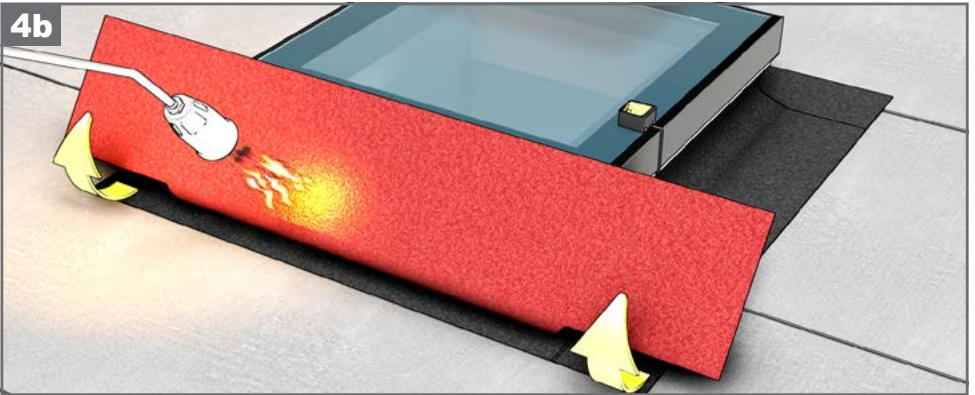

4c

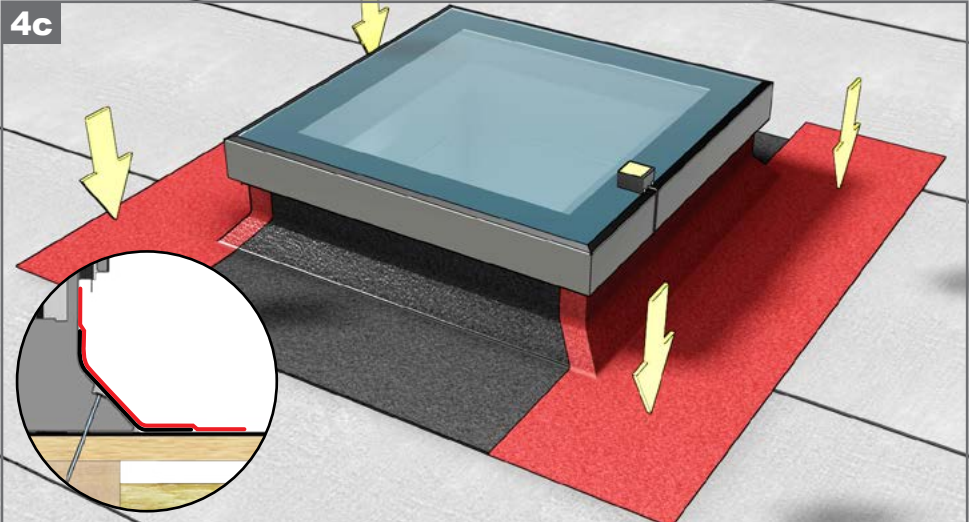

4c

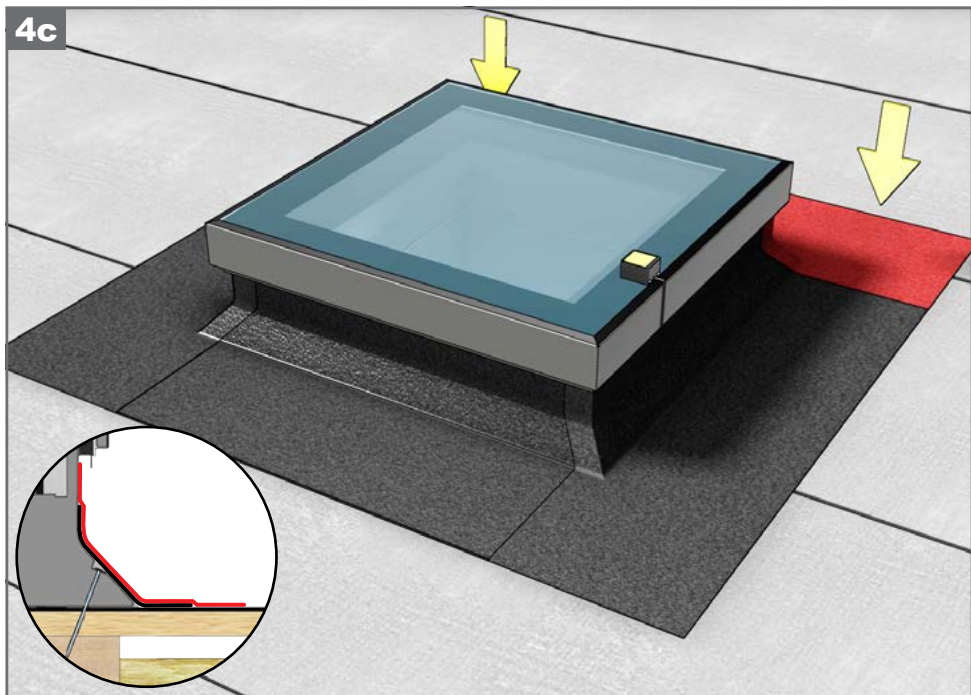

5a

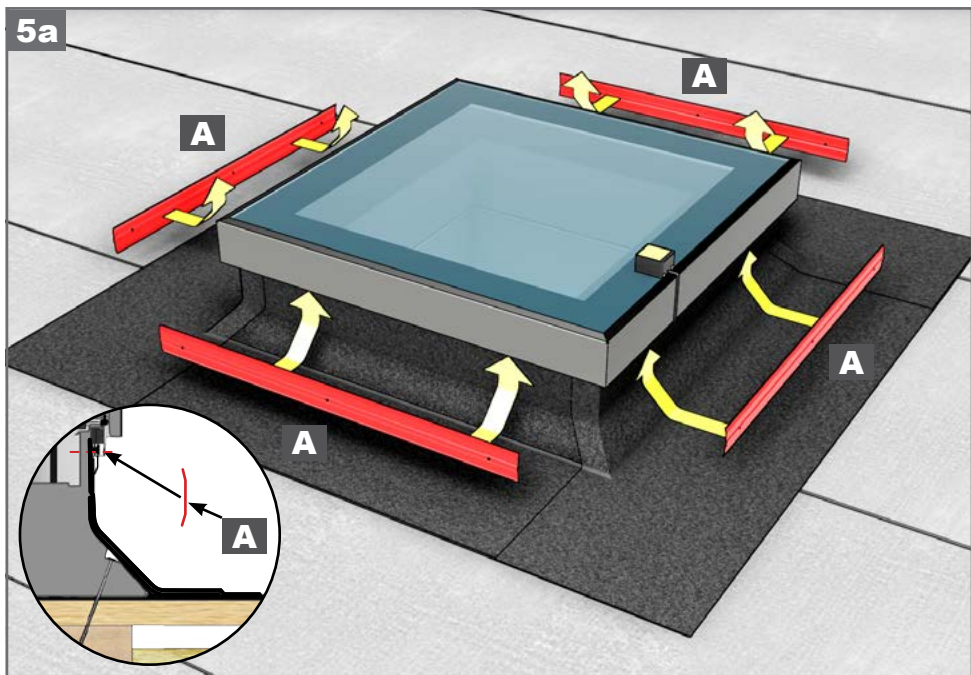

Uwaga! Proszę przeprowadzić niezbędną konfigurację użytkownika wg instrukcji. Jeśli procedura nie zostanie przeprowadzona - ze względów bezpieczeństwa - należy odłączyć okno od źródła zasilania!

Attention! Please carry out the necessary user configuration according to the instructions. If the procedure is not carried out - for safety reasons - disconnect the window from the power supply!

Achtung! Bitte führen Sie die notwendige Benutzerkonfiguration gemäß der Anleitung durch. Wird der Vorgang nicht durchgeführt, ist das Fenster aus Sicherheitsgründen von der Stromversorgung zu trennen!

Atención! Realice la configuración de usuario necesaria según las instrucciones. ¡Si el procedimiento no se lleva a cabo - por razones de seguridad - desconecte la ventana de la fuente de alimentación!

Atenção! Efetuar a configuração necessária do utilizador de acordo com as instruções. Se o procedimento não for efectuado - por razões de segurança - desligue a janela da alimentação eléctrica!

Let op! Voer de noodzakelijke stappen uit volgens de instructies met de QR code hieronder. Hiermee stelt u uw raam in voor bediening via uw smartphone. Als deze procedure niet wordt uitgevoerd, koppel dan het raam los van de stroomvoorziening i.v.m. veiligheidsredenen!

Attenzione! Eseguire la configurazione utente necessaria secondo le istruzioni. Se la procedura non viene eseguita - per motivi di sicurezza - scollegare la finestra dall'alimentazione!

Attention! Veuillez procéder à la configuration nécessaire de l'utilisateur conformément aux instructions. Si la procédure n'est pas exécutée - pour des raisons de sécurité - débranchez la fenêtre de l'alimentation électrique !



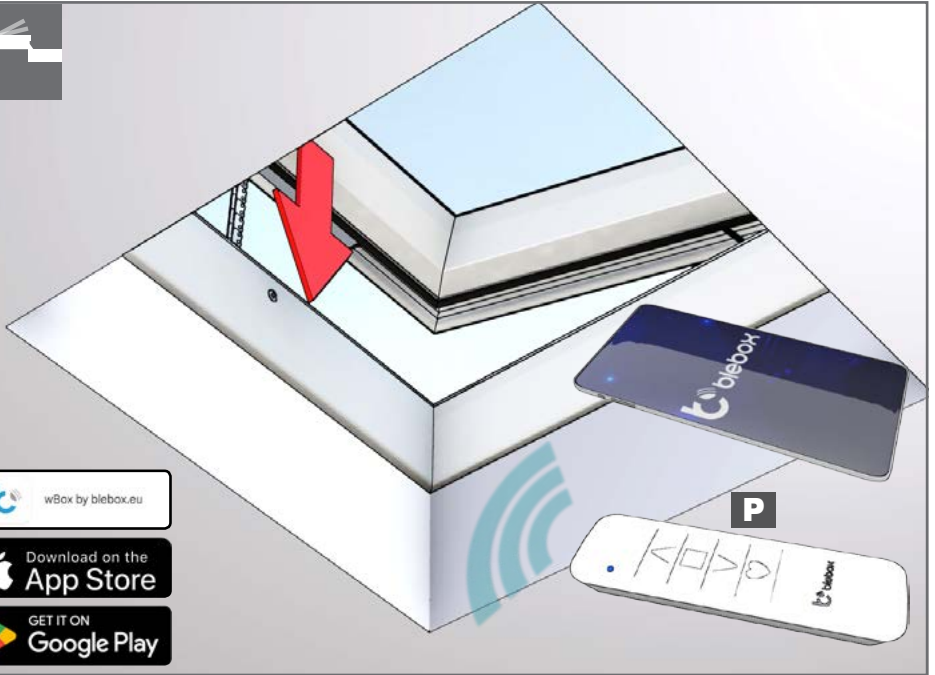
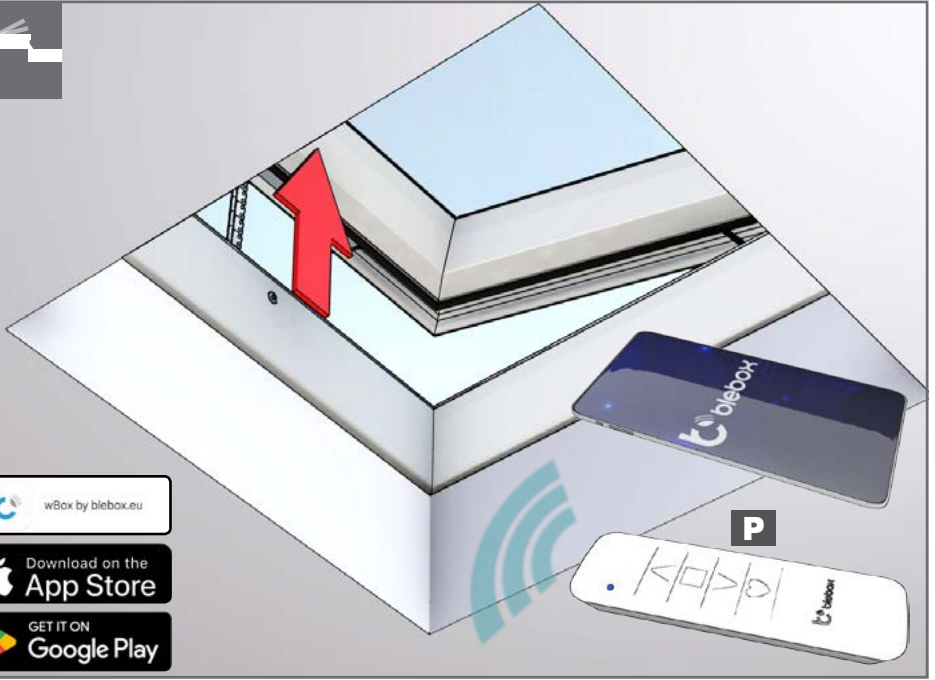

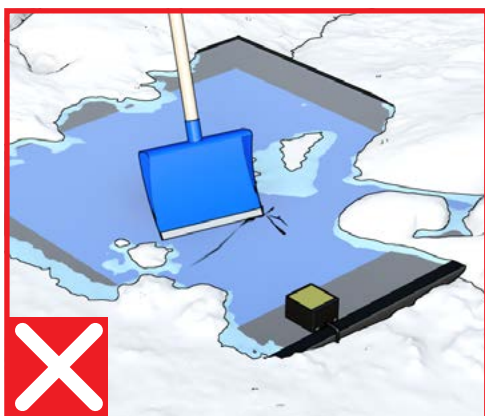
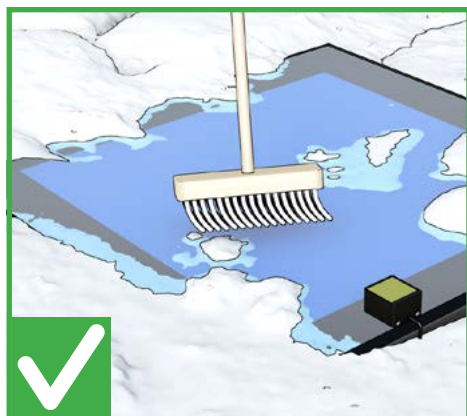
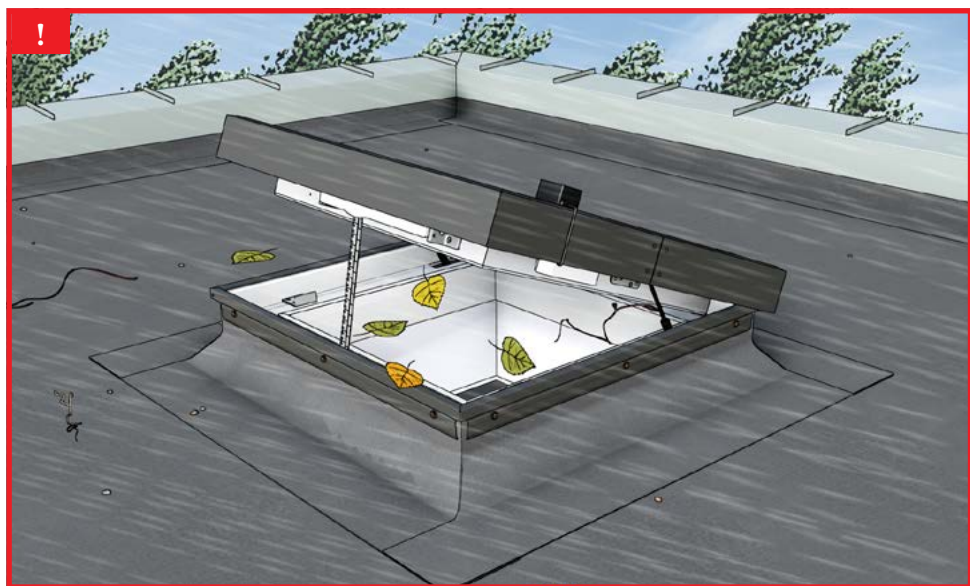
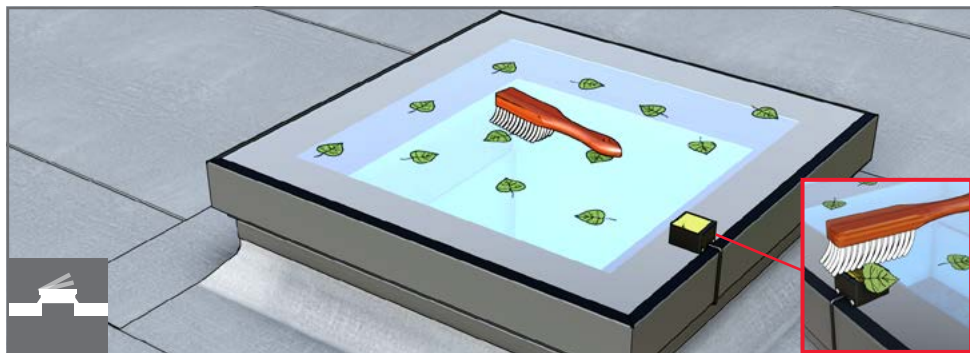

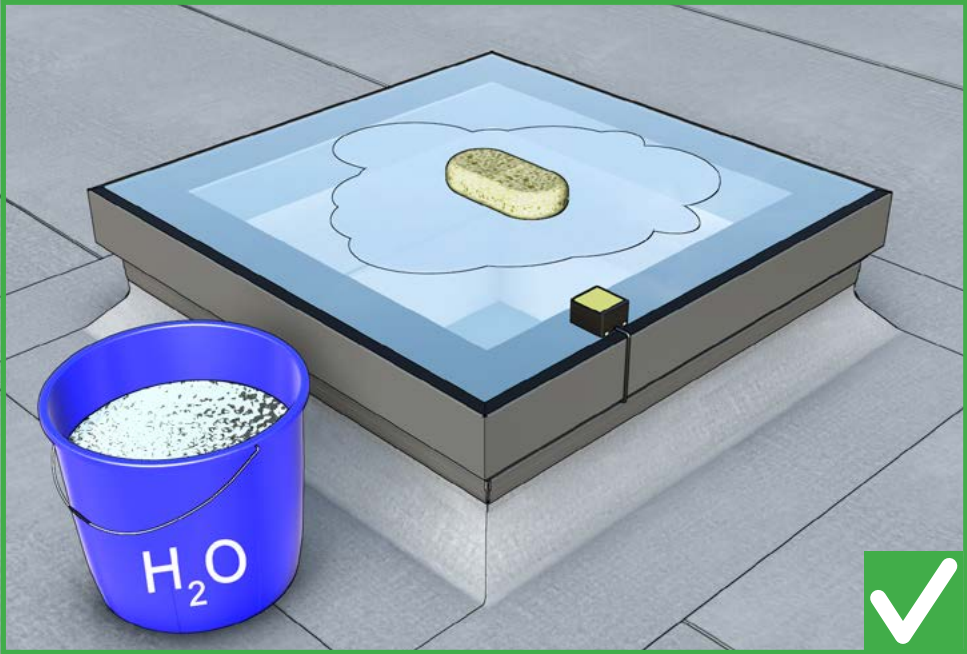

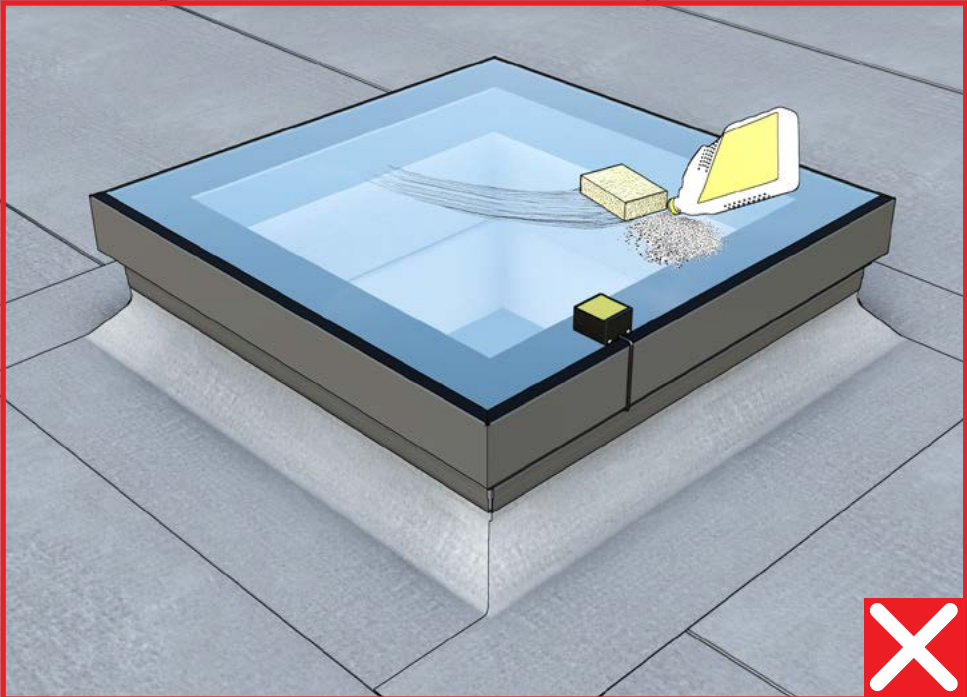
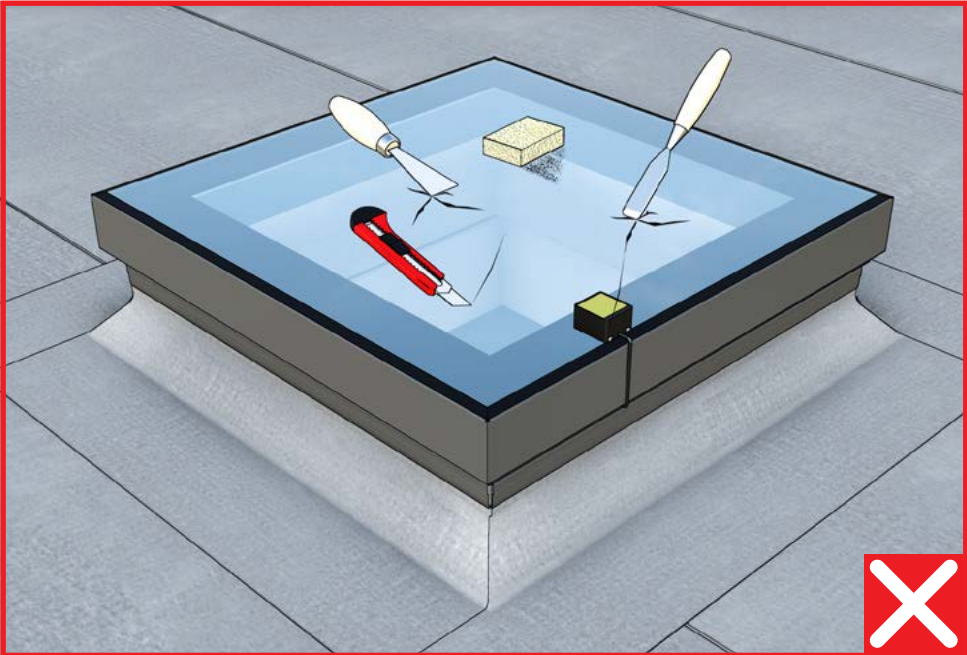

1 x YEAR

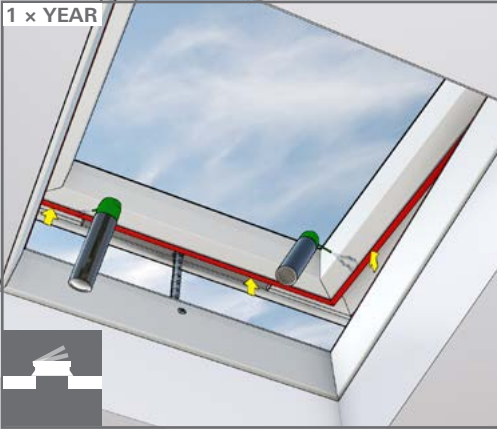

1 x YEAR

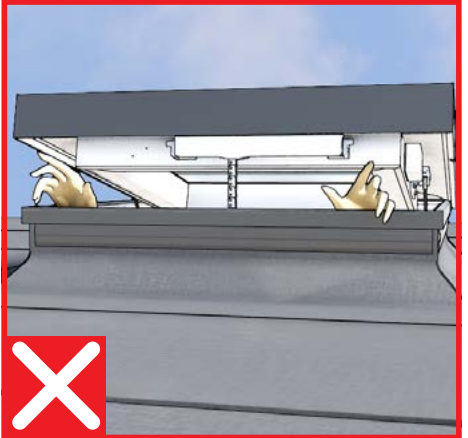
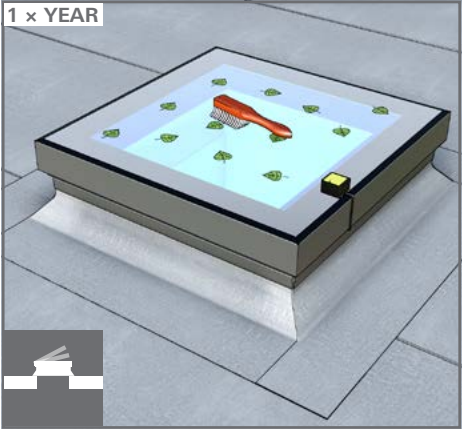

The manufacturer reserves that it will not incur any liability for failure to comply with safety requirements and laws as well as construction law by the owner, operator, fitter and architect.